



CS4/G - Lincat Silverlink 600 Electric Counter-top Chip Scuttle with Overhead Gantry - W 450 mm - 1.0 kW

Keep chips and other fried food deliciously crisp and succulent with the Silverlink 600 Electric Chip Scuttle.

- ✔ Heated from above and below to maintain even temperature of food
- ✔ Overhead heat lamp imparts a warm glow on the food being held
- ✔ Provide a continuous supply of chips and other fried food, quickly and easily
- ✔ Crisp chips, the perforated drain plates ensures any excess oil is drained away
- ✔ Adjustable temperature control
- ✔ Removable 1/1 GN size chip container for convenience and ease of cleaning

Specifications

Summary

Brand	Lincat
Range	Silverlink 600
Power Type	Electric
Unit Type	Counter-top
Available in UK Only	No
UK Warranty	2 Years Parts and Labour Warranty
Export Warranty	Contact your local dealer
GTIN	5056105100065

Power and Performance

Total Power kW	1.00
IP Rating	IP33
Temperature Control	Mechanical

Key Specifications

Heated Base	Yes
Heated Gantry	Yes

Capacity

Gastronorm Capacity	1 x GN1/1
----------------------------	-----------

Weights and Dimensions

Unit Height (External) mm	645
Unit Width (External) mm	450
Unit Depth (External) mm	600
Net Weight Kg	16.5

Supply Connections

Requires Installation	No
Requires Electrical Supply	Yes
UK 3 Pin Plug	Yes
Requires Hardwiring	No
Electrical Supply Rating Watts	1,000
Single Phase Amps	4.3
Single Phase Voltage	230

Shipping

Packed Weight Kg	22.9
Packed Height cm	88.3
Packed Width cm	70.3
Packed Depth cm	70.3

Available Accessories

CC4	Lincat Silverlink 600 Free-standing Ambient Open-Top Pedestal with Doors - W 450 mm
CN4	Lincat Silverlink 600 Free-standing Ambient Open-Top Pedestal without Doors - W 450 mm
HC4	Lincat Silverlink 600 Free-standing Heated Open-Top Pedestal with Doors - W 450 mm - 0.5 kW
HCL4	Lincat Silverlink 600 Free-standing Heated Pedestal with Legs and Doors - W 450 mm - 0.5 kW

Available Accessories

SLS4

Lincat Silverlink 600 Free-standing Floor Stand - for units W 450 mm

Technical Picture

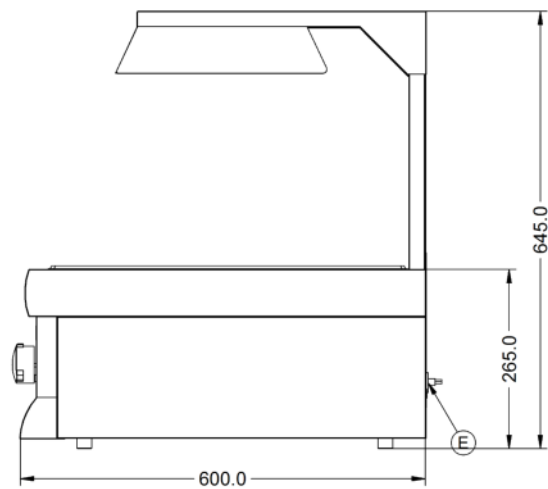
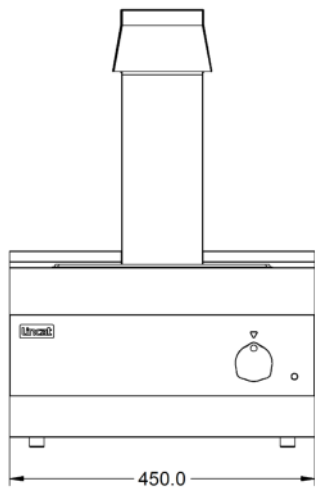
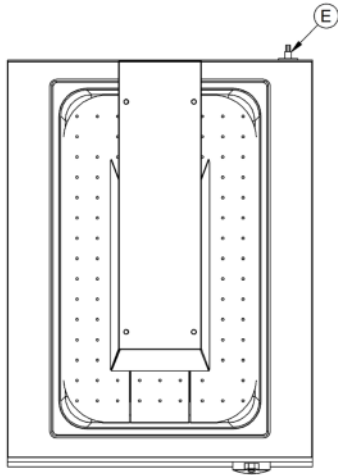



Lincat Limited

Whisby Road,
Lincoln, LN6 3QZ,
United Kingdom

Company No: 2175448

A member company of



Customer Care

Tel: +44 1522 875500
Email: care@lincat.co.uk

Export Customers

Tel: +44 1522 503250
Email: export@lincat.co.uk

Opening Hours

Monday – Friday:
8.30am – 5pm